

ASX 176/FO

High Medium Pressure Gas Regulator

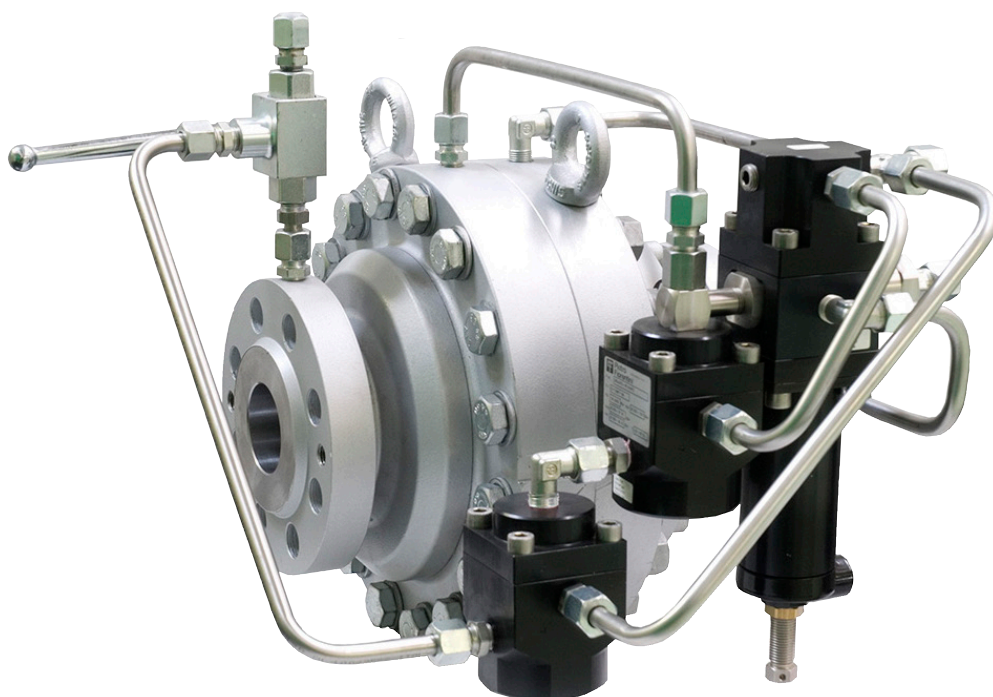

TECHNICAL BROCHURE

Pietro Fiorentini S.p.A.

Via E.Fermi, 8/10 | 36057 Arcugnano, Italy | +39 0444 968 511
sales@fiorentini.com

The data are not binding. We reserve the right
to make changes without prior notice.

asx176fo_technicalbrochure_ENG_revA

www.fiorentini.com

Who we are

We are a global organization specialized in designing and manufacturing technologically advanced solutions for natural gas treatment, transmission and distribution systems.

We are the ideal partner for operators in the Oil & Gas sector, with a business offer that goes across the whole natural gas chain.

We are in constant evolution to meet our customers' highest expectations in terms of quality and reliability.

Our aim is to be a step ahead of the competition, with customized technologies and an after-sale service program undertaken with the highest grade of professionalism.



Pietro Fiorentini advantages



Localised technical support



Experience since 1940



We operate in over 100 countries

Area of Application

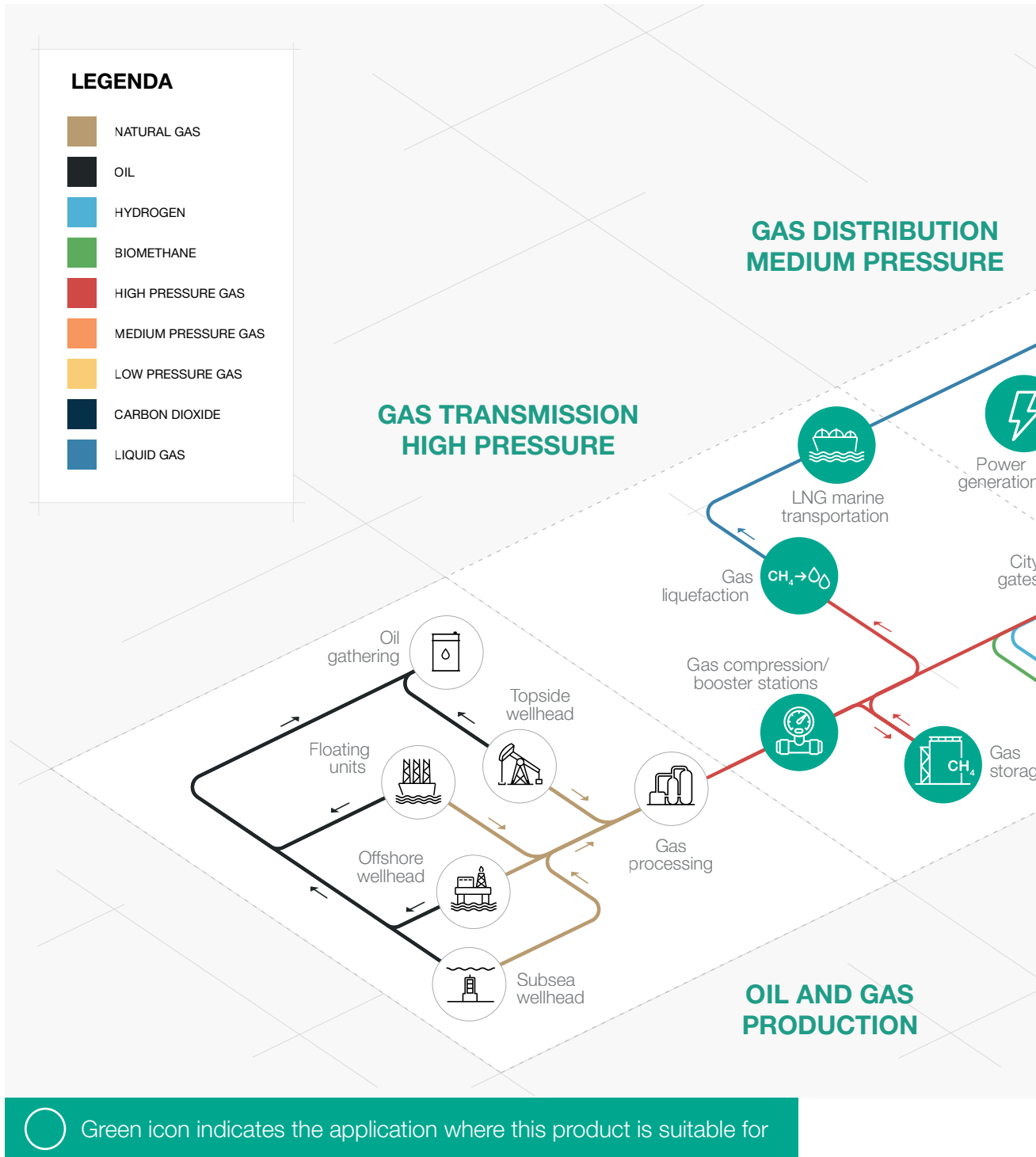

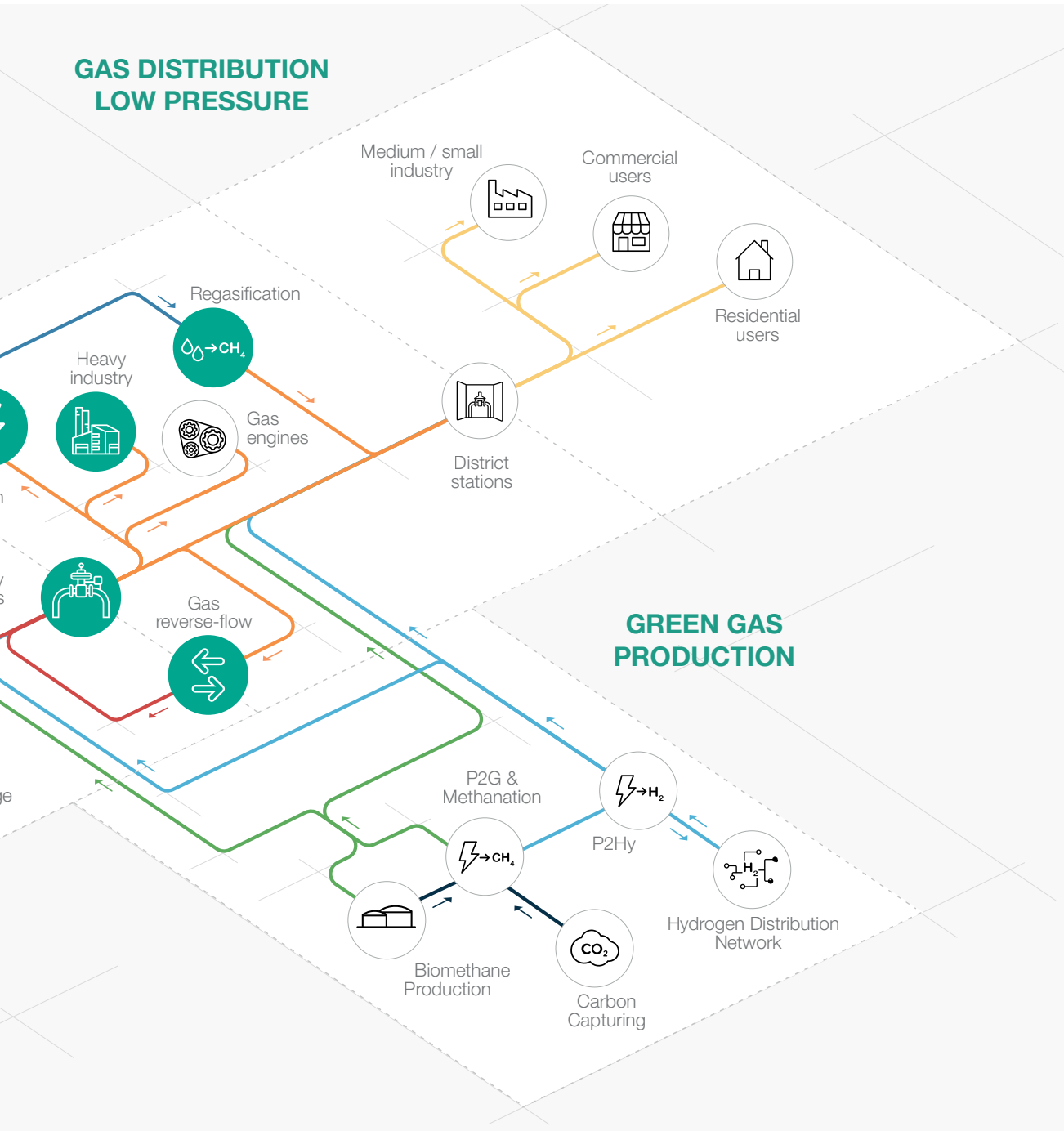

Figure 1 Area of Application Map



Introduction

ASX 176/FO is one of the **pilot-operated gas pressure regulators** designed and manufactured by Pietro Fiorentini.

This device is suitable for use with previously filtered non-corrosive gases, and it is mainly used for high-pressure transmission systems and for medium pressure natural gas distribution networks.

According to the European Standard EN 334, it is classified as **Fail Open**.

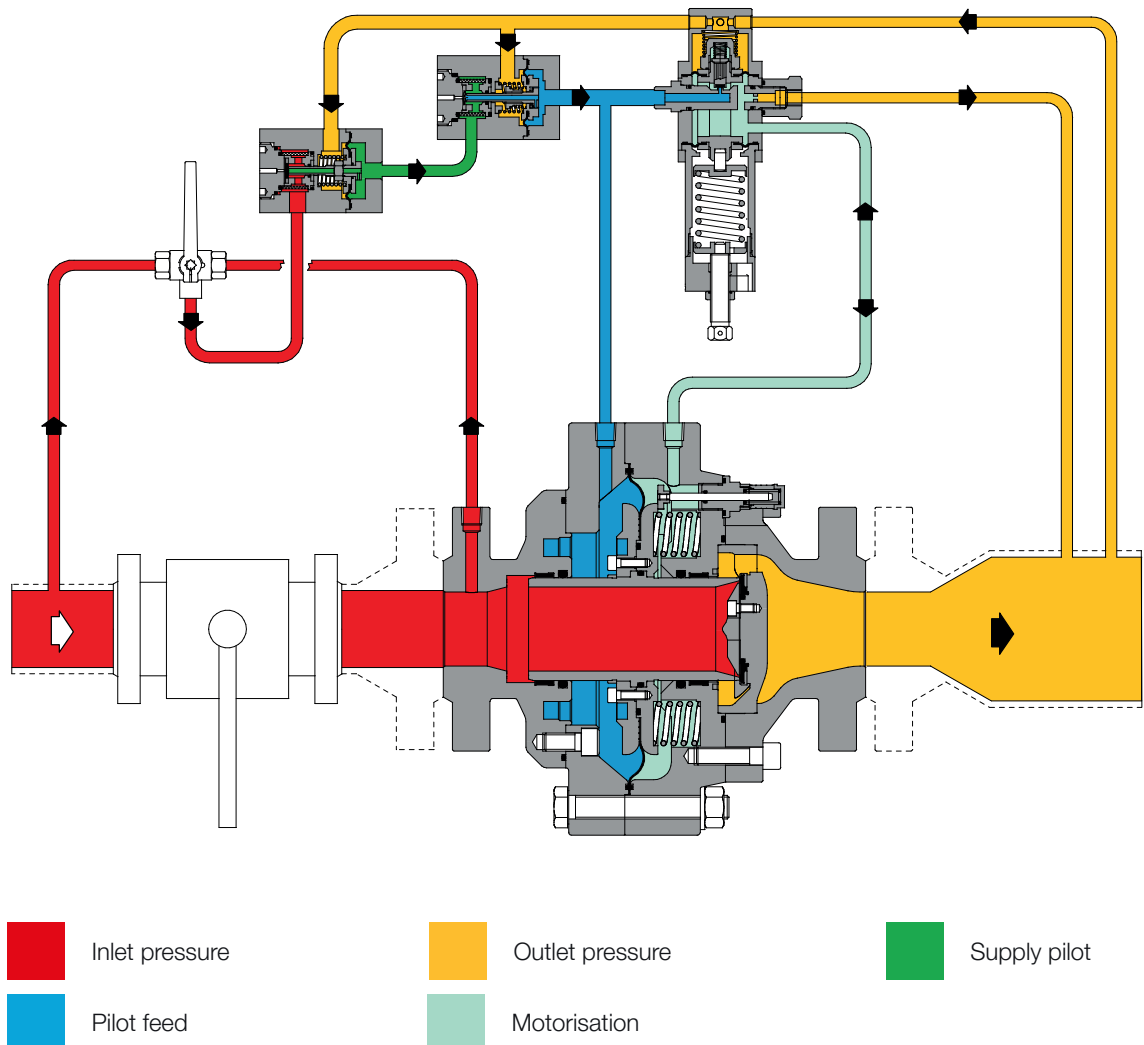

Figure 2 ASX 176/FO

Features and Calibration ranges

ASX 176/FO is a **pilot-operated** device for high pressure and medium pressure with a unique **dynamic balancing system** which ensures an **outstanding turn down ratio** combined with an extremely **accurate outlet pressure control**.

ASX 176/FO is a balanced pressure regulator. This means that the controlled outlet pressure is not affected by variations in the inlet pressure and flow during its operation. Therefore a balanced regulator can have a single-size orifice for all pressure and flow conditions.

This regulator is suitable for use with previously filtered, non corrosive gases, in natural gas transmission and distribution networks as well as high load industrial application.

Set point adjustment of the regulator is operated via a pilot unit used to control the motorization pressure to the diaphragm chamber.

It is an axial flow regulator with higher capacity compared to the same size top entry body regulators.

The **body form factor** makes it very **reliable** for applications with high **elemental sulphur** presence in the gas stream.

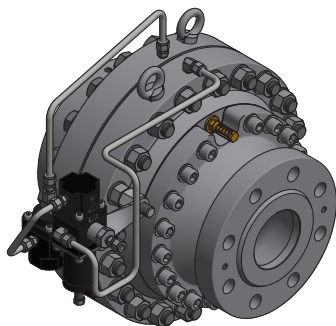

Figure 3 ASX 176/FO

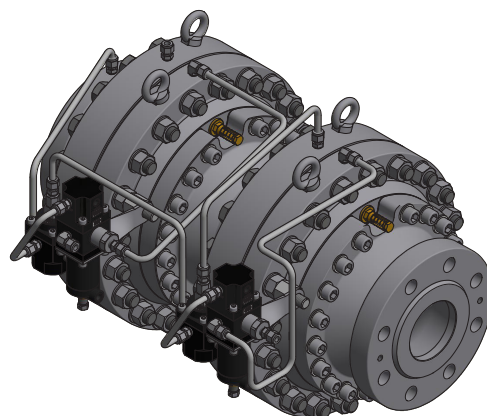

Figure 4 ASX 176/FO with PM/176



ASX 176/FO competitive advantages



Balanced type



High accuracy



High turn-down ratio



True Fail Open plug and seat regulator



Built-in pilot filter



High capacity



High reliability vs elemental sulphur presence



Biomethane compatible and available with specific versions for full Hydrogen or blending

Features

Features	Values
Design pressure*	up to 10.2 MPa up to 102 barg
Ambient temperature*	from -20 °C to +60 °C from -4 °F to +140 °F
Inlet gas temperature range*	from -20 °C to +60 °C from -4 °F to +140 °F
Inlet pressure range bpu (MAOP)	from 0.3 to 10 MPa from 3 to 100 barg
Range of downstream pressure Wd	from 0.1 to 7.4 MPa from 1 to 74 barg
Available Accessories	LDB/176 Silencer, PM/176 Monitor, SSX/176 Slam shut
Minimum differential pressure	0.2 MPa 2 barg
Accuracy class AC	up to 2.5
Lock-up pressure class SG	up to 10
Nominal dimensions DN	DN 25 / 1"; DN 50 / 2"; DN 80 / 3"; DN 100 / 4"; DN 150 / 6"
Connections*	Class 300, 600 RF or RTJ according to ASME B16.5

(*) REMARK: Different functional features and/or extended temperature ranges available on request. Stated temperature ranges are the maximum for which the equipment's full performance, including accuracy, are fulfilled. Standard product may have a narrower range.

Table 1 Features

Materials and Approvals

Part	Material
Body	Steel ASTM A350 LF2
Plug	ASTM A 350 LF2 Nickel coated on sealing surface
Seat	Polimer / Nitril rubber vulcanized on a metal support
Diaphragm	Rubberized canvas (performed by hot-pressing process)
Sealing ring	Nitrile rubber
Compression fittings	In zinc-plated carbon steel according to DIN 2353; Stainless steel on request

REMARK: The materials indicated above refer to the standard models. Different materials can be provided according to specific needs.

Table 2 Materials

Construction Standards and Approvals

ASX 176/FO regulator, is designed according to the European standard EN 334. The regulator reacts in opening (Fail Open) according to EN 334.

The product is certified according to European Directive 2014/68/EU (PED). Leakage class: bubble tight, better than VIII according to ANSI/FCI 70-3.



EN 334



PED-CE



Pilot ranges and types

Type	Model	Operation	Range Wh		Spring Table web link
			MPa	barg	
Main pilot	204/A/FO	Manual	0.1 - 3.3	1 - 33	TT 1183
Main pilot	205/A/FO	Manual	2 - 6	20 - 60	TT 1183
Main pilot	207/A/FO	Manual	4.1 - 7.4	41 - 74	TT 1183

Table 3 Settings table

Pilot adjustment	
Pilot type .../A	Manual setting
Pilot type .../D	Electric remote control setting
Pilot type .../CS	Pneumatic remote control setting
Pilot type .../FIO	Smart unit for remote setting, monitoring, flow limitation

Table 4 Pilot adjustment table

General link to the calibration tables: [PRESS HERE](#) or use the QR code:



Accessories

For the pressure regulators:

- Cg limiter
- Limit switches
- Position transmitter
- Silencer
- Slam shut valve
- Monitor

For the pilot circuit:

- R14/A/S preregulator for the high pressure circuit (differential pressure > 3.5 MPa | 35 barg)
- Heating cable for preheating pilot circuit
- Electrical heater PPH200
- Supplementary filter CF14 or CF14/D
- ATF 15 antifreeze

In-line Monitor

The in-line monitor is generally installed **upstream** of the active regulator.

Although the function of the monitor regulator is different, the two regulators are virtually identical from the point of view of their mechanical components.

The only difference is that the monitor is set at a higher pressure than the active regulator.

The Cg coefficient of the active regulator is the same, however during the sizing process, the differential pressure drop generated by the fully open in-line monitor shall be considered. As a general practise to incorporate this effect, a 20% reduction of the Active regulator's Cg value can be applied.

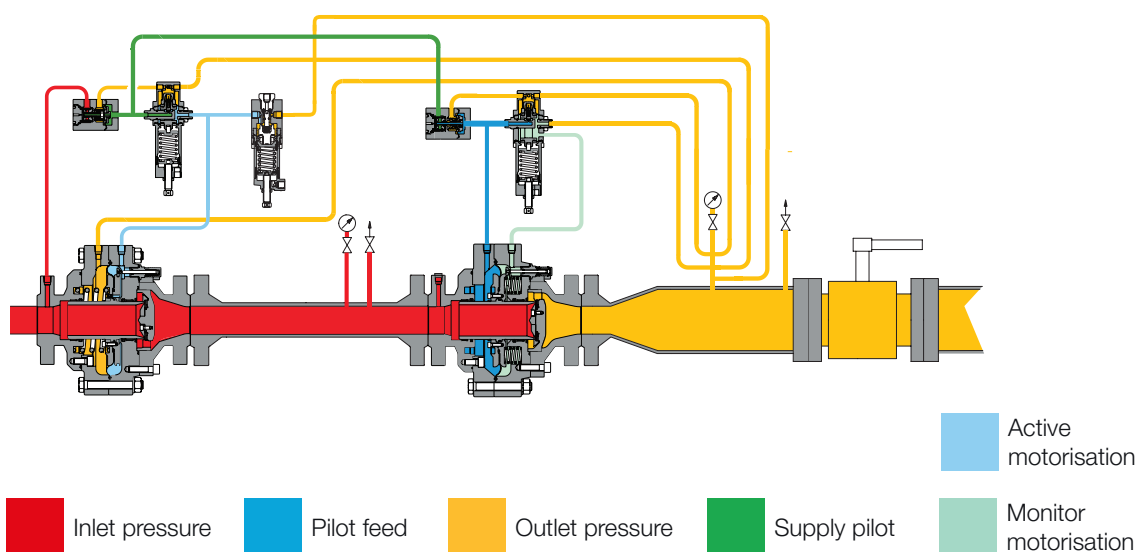

Figure 5 ASX 176/FO with In-line monitor ASX 176



PM/176 monitor

This emergency regulator (monitor) is attached to the body of the main regulator. Both pressure regulators, therefore, use the same valve body, although they have independent actuators, pilots and valve seats.







The monitor is in the fully open position during normal operation of the active regulator and takes over on in the event of its failure.

The functional characteristics of the PM/176 monitor are the same of the basic regulator ASX 176/FO.

The Cg coefficients of regulator having an incorporated monitor is 16% lower than those for standard version.

This solution allows the construction of pressure reduction lines with compact dimensions.

Another great advantage offered by the incorporated monitor regulator is that **it can be installed at any time**, even on an existing regulator, **but it requires changes to the pipework.**

-  Completely independent
-  "Fail to close" action
-  Built-in pilot filter
-  Visual opening indicator
-  Limit switch option
-  Accelerator option

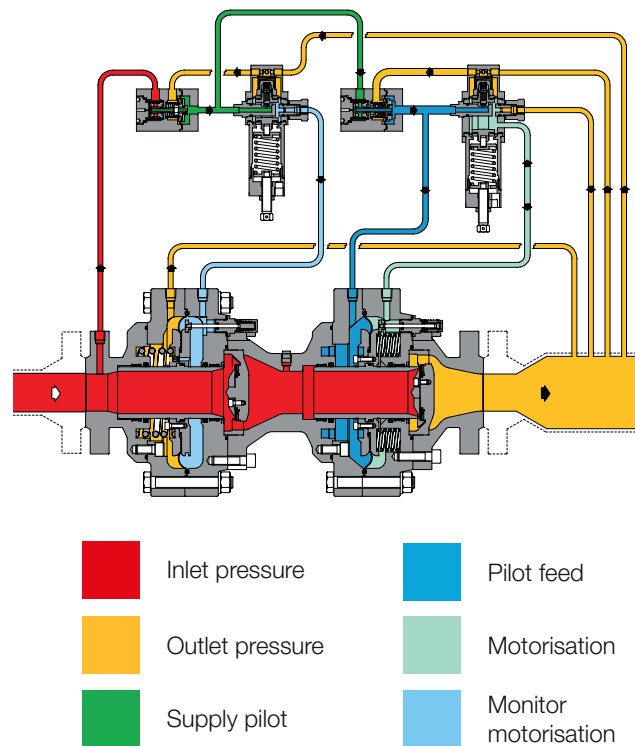

Figure 6 ASX 176/FO with PM/176

Type	Model	Operation	Range Wh		Spring Table web link
			MPa	barg	
Main pilot	204/A	Manual	0.03 - 4.3	0.3 - 43	TT 433
Main pilot	205/A	Manual	2 - 6	20 - 60	TT 799
Main pilot	207/A	Manual	4.1 - 7.4	41 - 74	TT 1146

Table 5 Setting table

Types of pilot adjustment	
Pilot type .../A	Manual setting
Pilot type .../D	Electric remote control setting
Pilot type .../CS	Pneumatic remote control setting
Pilot type .../FIO	Smart unit for remote setting, monitoring, flow limitation

Table 6 Pilot adjustment table

The monitor regulator can be equipped with an additional pilot called “accelerator” to enable a quick response time during the monitor take over. According to PED the accelerator is required on the monitor when acting as a safety accessory.

Type	Model	Operation	Range Wh		Spring Table web link
			MPa	barg	
Accelerator	M/A	Manual	0.03 - 2	0.3 - 20	TT 354
Accelerator	M/A1	Manual	2 - 6.3	20 - 63	TT 892
Accelerator	M/A2	Manual	4 - 7.5	40 - 75	TT 892

Table 7 Accelerator adjustment table

General link to the calibration tables: [PRESS HERE](#) or use the QR code:





LDB/176 silencer

Whenever certain noise limit is desired, an additional silencer allows to considerably reduce the noise level (dBA).

ASX 176/FO pressure regulator can be supplied with an **incorporated silencer** in either the standard version or version with incorporated slam shut or monitor regulator.

The high efficiency noise absorption takes place at the point where the noise is generated, thus preventing its propagation.

With the built-in silencer, the Cg valve coefficient is 10% lower than the corresponding version without.

Given the modular arrangement of the regulator, the silencer may be retrofitted to both standard ASX 176/FO version as well as those with incorporated slam shut or monitor, **without any need to modify the main piping.**

Pressure reduction and control operate in the same manner as in the standard version.

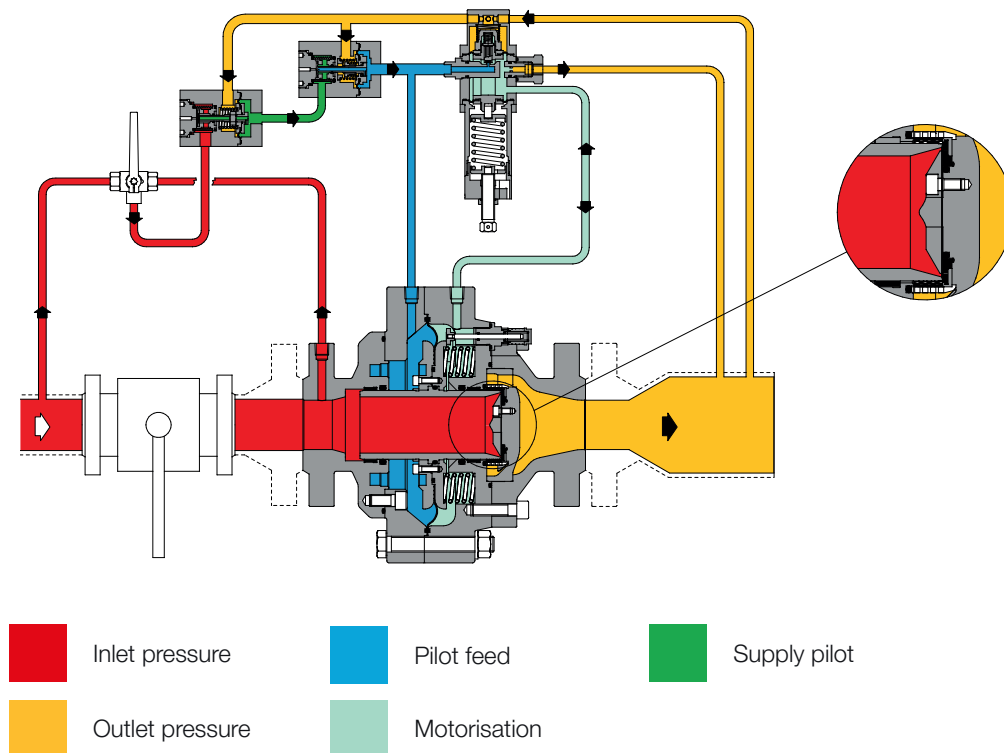

Figure 7 ASX 176/FO with Silencer LDB/176

The charts below represent the silencer effectiveness based on some common reference conditions for 2", 4" and 6". For actual calculations at specific desired conditions please refer to the online sizing tool or contact your closest Pietro Fiorentini representative.

- Pd 0.4 MPa | 4 barg NO Silencer
- Pd 0.4 MPa | 4 barg LDB/176
- Pd 2 MPa | 20 barg NO SILENCER
- Pd 2 MPa | 20 barg LDB/176
- Pd 4 MPa | 40 barg NO Silencer
- Pd 4 MPa | 40 barg LDB/176
- Recommended noise limit (85 dBA at 1 mt | 3 feet)

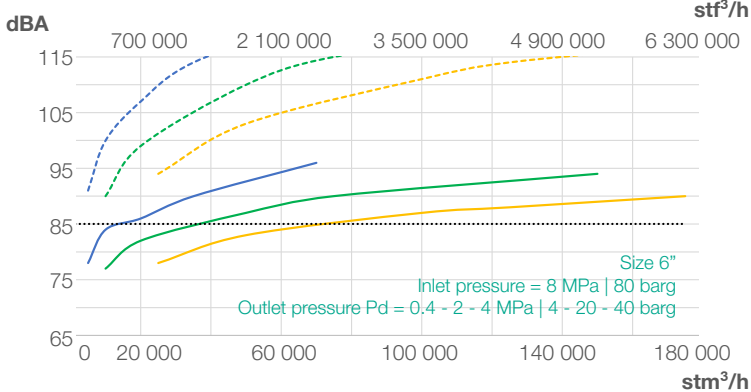
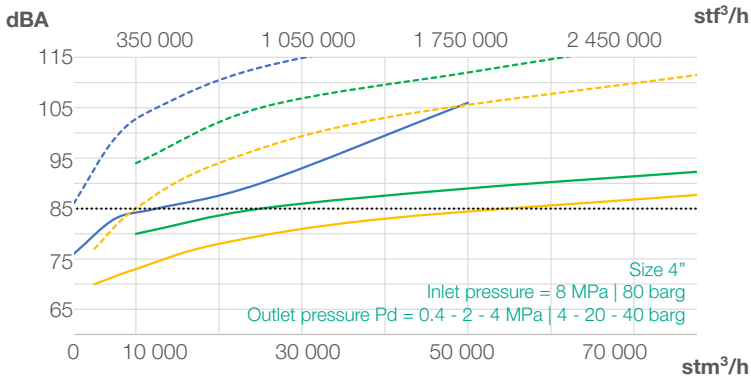
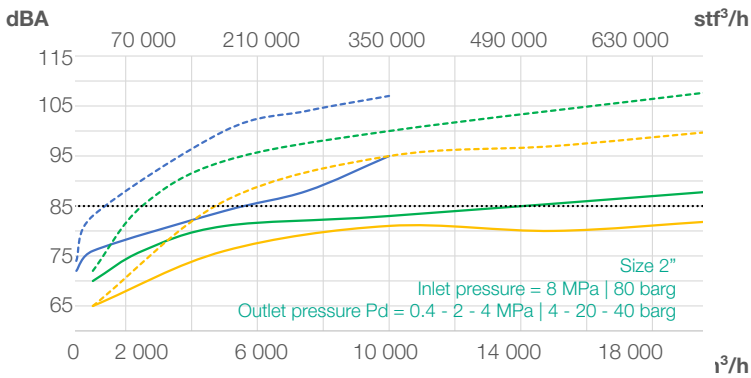
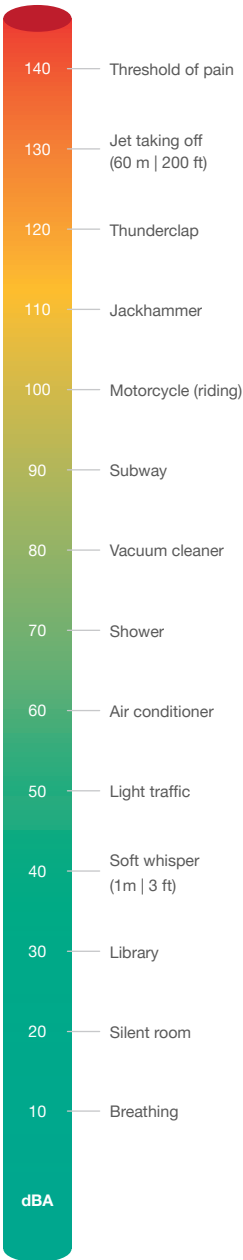

Chart 1 ASX 176/FO's silencer efficiency charts









SSX/176 slam shut

ASX 176/FO pressure regulator offers the possibility of installing an **SSX/176 incorporated slam shut valve**, depending on the regulator size, and this can be done either during the manufacturing process or be retrofitted in the field.

Retrofitting can be done without modifying the pressure regulator assembly, **but it requires modification to the main piping.**

With the built-in slam shut, the Cg valve coefficients is 20% lower than the corresponding version without.

The main characteristics of this device are:

-  OPSO Over Pressure Shut-Off
-  UPSO Under Pressure Shut-Off
-  Internal by-pass
-  Push button for tripping test
-  Compact dimensions
-  Remote tripping option
-  Limit switch option

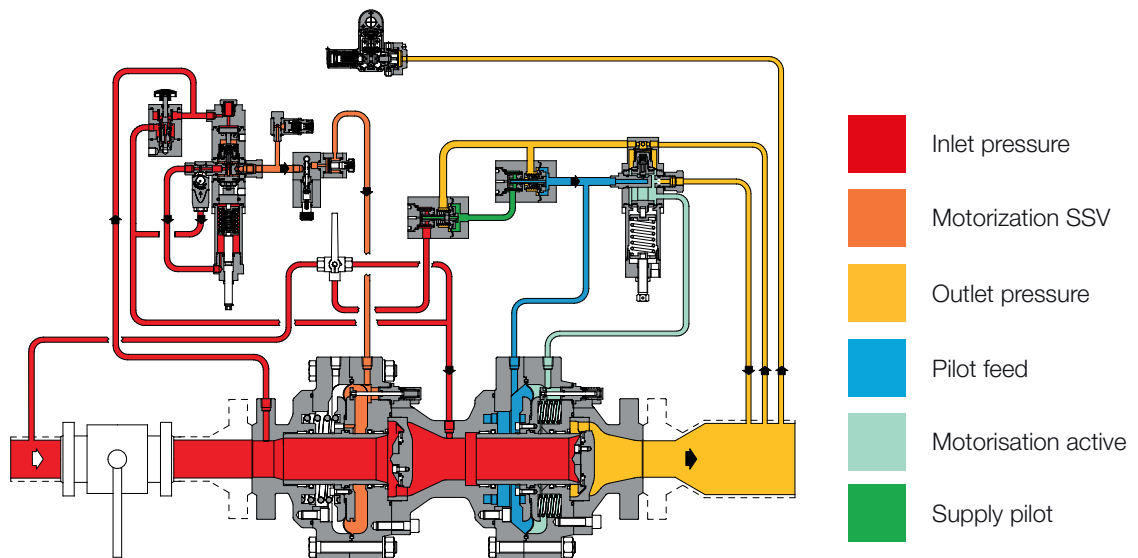

Figure 8 ASX 176/FO with SSX/176

Pressure switch types and ranges					
SSV Type	Model	Operation	Range Wh		Spring Table web link
			MPa	barg	
SSX/176	103M	OPSO	0.2 - 2.2	2 - 22	TT 1331
		UPSO	0.02 - 0.8	0.2 - 8	
SSX/176	104M	OPSO	1.5 - 4.5	15 - 45	TT 1331
		UPSO	0.16 - 1.8	1.6 - 18	
SSX/176	105M	OPSO	3 - 9	30 - 90	TT 1331
		UPSO	0.3 - 4.4	3 - 44	

Table 8 Setting table

General link to the calibration tables: [PRESS HERE](#) or use the QR code:





Weights and Dimensions

ASX 176/FO with or without LDB/176 silencer

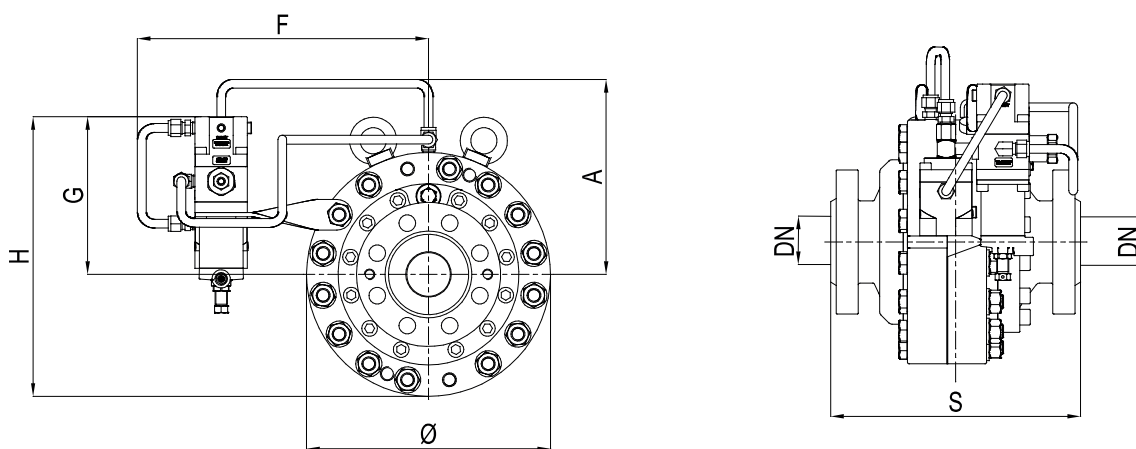

Figure 9 ASX 176/FO dimensions

Weights and Dimensions (for other connections please contact your closest Pietro Fiorentini representative)					
	[mm] inches	[mm] inches	[mm] inches	[mm] inches	[mm] inches
Size (DN)	25 1"	50 2"	80 3"	100 4"	150 6"
S - ANSI 300	197 7.76"	267 10.51"	317 12.48"	368 14.49"	473 18.62"
S - ANSI 600	210 8.27"	286 11.26"	336 13.23"	394 15.51"	508 20"
Ø	279 10.98"	279 10.98"	359 14.13"	440 17.32"	550 21.65"
A	180 7.09"	180 7.09"	223 8.78"	263 10.35"	318 12.52"
F	335 13.19"	335 13.19"	375 14.76"	409 16.10"	465 18.31"
G	181 7.13"	181 7.13"	186 7.32"	203 7.99"	201 7.91"
H	321 12.64"	321 12.64"	365 14.37"	425 16.73"	476 18.74"
Tubing connections	Øe 10 x Øi 8 (on request imperial sizing)				

Weight	Kg lbs	Kg lbs	Kg lbs	Kg lbs	Kg lbs
ANSI 300	55 121	72 159	123 271	214 472	333 734
ANSI 600	55 121	74 163	126 278	225 496	365 805

Table 9 Weights and dimensions

ASX 176/FO + PM/176 with or without LDB/176 silencer

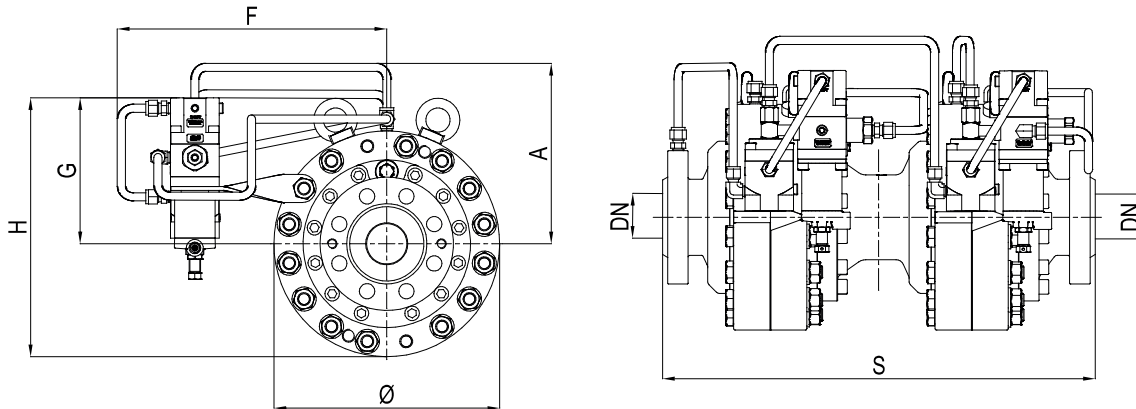

Figure 10 ASX 176/FO + PM/176 dimensions

Weights and Dimensions (for other connections please contact your closest Pietro Fiorentini representative)					
	[mm] inches	[mm] inches	[mm] inches	[mm] inches	[mm] inches
Size (DN)	25 1"	50 2"	80 3"	100 4"	150 6"
S - ANSI 300	372 14.65"	516 20.31"	581 22.87"	694 27.32"	901 35.47"
S - ANSI 600	385 15.16"	535 21.06"	600 23.62"	720 28.34"	936 36.85"
Ø	279 10.98"	279 10.98"	359 14.13"	440 17.32"	550 21.65"
A	180 7.09"	180 7.09"	223 8.78"	263 10.35"	318 12.52"
F	335 13.19"	335 13.19"	375 14.76"	409 16.10"	465 18.31"
G	181 7.13"	181 7.13"	186 7.32"	203 7.99"	201 7.91"
H	321 12.64"	321 12.64"	365 14.37"	425 16.73"	476 18.74"
Tubing connections	Øe 10 x Øi 8 (on request imperial sizing)				
Weight	Kg lbs	Kg lbs	Kg lbs	Kg lbs	Kg lbs
ANSI 300	110 242	137 302	239 527	425 937	656 1446
ANSI 600	110 242	139 306	242 534	445 981	730 1609

Table 10 Weights and dimensions

ASX 176/FO + SSX/176 with or without LDB/176 silencer

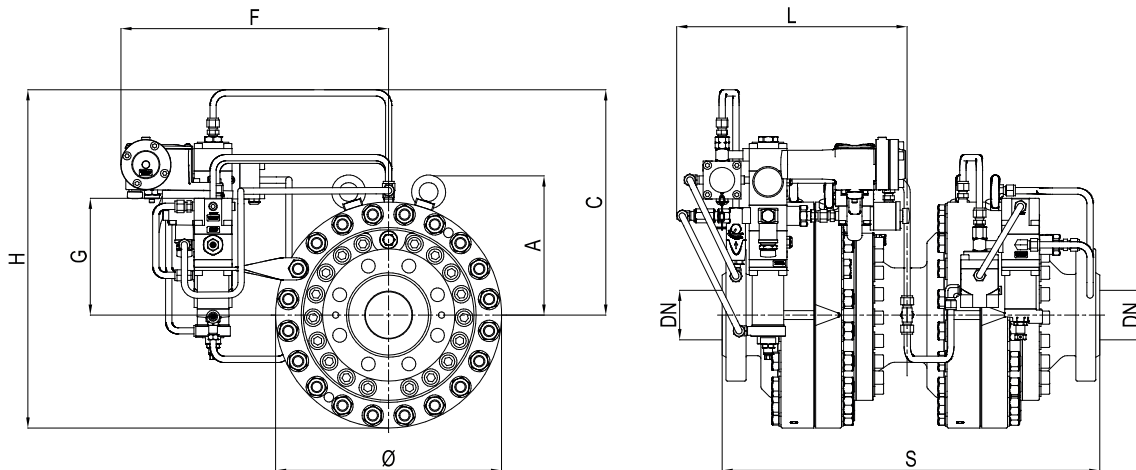

Figure 11 ASX 176/FO + SSX/176 dimensions

Weights and Dimensions (for other connections please contact your closest Pietro Fiorentini representative)					
	[mm] inches	[mm] inches	[mm] inches	[mm] inches	[mm] inches
Size (DN)	25 1"	50 2"	80 3"	100 4"	150 6"
S - ANSI 300	372 14.65"	516 20.31"	581 22.87"	694 27.32"	901 35.47"
S - ANSI 600	385 15.16"	535 21.06"	600 23.62"	720 28.34"	936 36.85"
Ø	279 10.98"	279 10.98"	359 14.13"	440 17.32"	550 21.65"
A	180 7.09"	180 7.09"	223 8.78"	263 10.35"	318 12.52"
C	346 13.62"	346 13.62"	352 13.85"	369 14.52"	388 15.27"
F	348 13.70"	348 13.70"	389 15.31"	425 16.73"	460 18.11"
G	181 7.13"	181 7.13"	186 7.32"	203 7.99"	201 7.91"
H	489 19.25"	489 19.25"	532 20.94"	590 23.22"	653 25.70"
L	284 11.18"	308 12.12"	365 14.37"	443 17.44"	523 20.59"
Tubing connections	Øe 10 x Øi 8 (on request imperial sizing)				

Weight	Kg lbs	Kg lbs	Kg lbs	Kg lbs	Kg lbs
ANSI 300	115 253	142 313	244 537	429 945	661 1457
ANSI 600	115 253	144 317	246 542	449 990	735 1620

Table 11 Weights and dimensions

Sizing and Cg

In general, the choice of a regulator is made based on the calculation of the flow rate determined by the use of formulae using the flow rate coefficients (Cg) and the form factor (K1) as indicated by the EN 334 standard.

Flow rate coefficient					
Nominal size	25	50	80	100	150
Inches	1"	2"	3"	4"	6"
Cg	630	2300	5000	8800	19000
K1	145	145	145	145	145

Table 12 Flow rate coefficient

For sizing [PRESS HERE](#) or use the QR code:



Note: In case you do not have the proper credentials to access, feel free to contact your closest Pietro Fiorentini representative.

In general, the online sizing considers multiple variables as the regulator is installed in a system, enabling a better and multiperspective approach to the sizing.

For different gases, and for natural gas with a different relative density other than 0.61 (compared to air), the correction coefficients from the following formula shall be applied:

$$F_c = \sqrt{\frac{175,8}{S \times (273,16 + T)}}$$

S = relative density (refer to table 13)
T = gas temperature (°C)



Correction Factor Fc		
Gas Type	Relative Density S	Correction Factor Fc
Air	1.00	0.78
Propane	1.53	0.63
Butane	2.00	0.55
Nitrogen	0.97	0.79
Oxygen	1.14	0.73
Carbon Dioxide	1.52	0.63

Note: the table shows the Fc correction factors valid for Gas, calculated at a temperature of 15°C and at the declared relative density.

Table 13 Correction Factor Fc

Flow rate conversion
Stm ³ /h x 0.94795 = Nm ³ /h

Nm³/h reference conditions T= 0 °C; P= 1 barg
 Stm³/h reference conditions T= 15 °C; P= 1 barg

Table 14 Flow rate conversion

CAUTION:

In order to get optimal performance, to avoid premature erosion phenomena and to limit noise emissions, it is recommended to check that the gas speed at the outlet flange does not exceed the values of the graph below. The gas speed at the outlet flange may be calculated by means of the following formula:

$$V = 345.92 \times \frac{Q}{DN^2} \times \frac{1 - 0.002 \times Pd}{1 + Pd}$$

V = gas speed in m/s
 Q = gas flow rate in Stm³/h
 DN = nominal size of regular in mm
 Pd = outlet pressure in barg

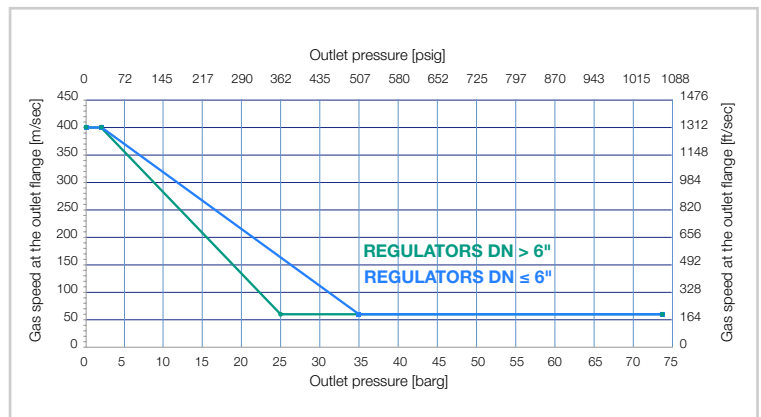

Sizing of regulators is usually made based on valve Cg value (table 12).

Flow rates at fully open position and various operating conditions are related by the following formulae where:

Q = flow rate in Stm³/h

Pu = inlet pressure in bar (abs)

Pd = outlet pressure in bar (abs).

- **A** > when the Cg value of the regulator is known, as well as Pu and Pd, the flow rate can be calculated as follows:

- **A-1** in sub critical conditions: (Pu < 2 x Pd)

$$Q = 0.526 \times C_g \times P_u \times \sin \left(K_1 \times \sqrt{\frac{P_u - P_d}{P_u}} \right)$$

- **A-2** in critical conditions: (Pu ≥ 2 x Pd)

$$Q = 0.526 \times C_g \times P_u$$

- **B** > vice versa, when the values of Pu, Pd and Q are known, the Cg value, and hence the regulator size, may be calculated using:

- **B-1** in sub-critical conditions: (Pu < 2xPd)

$$C_g = \frac{Q}{0.526 \times P_u \times \sin \left(K_1 \times \sqrt{\frac{P_u - P_d}{P_u}} \right)}$$

- **B-2** in critical conditions (Pu ≥ 2 x Pd)

$$C_g = \frac{Q}{0.526 \times P_u}$$

NOTE: The sin val is understood to be DEG.



TB0004ENG



The data are not binding. We reserve the right
to make changes without prior notice.

[asx176fo_technicalbrochure_ENG_revA](#)

www.fiorentini.com